

Aydınlatma Kataloğu

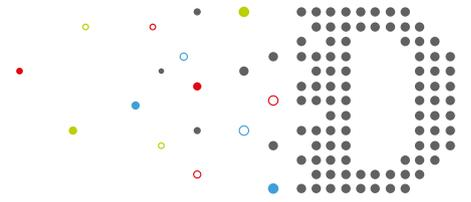

DLD[®]
DOĞUŞLED LIGHTING DESIGN

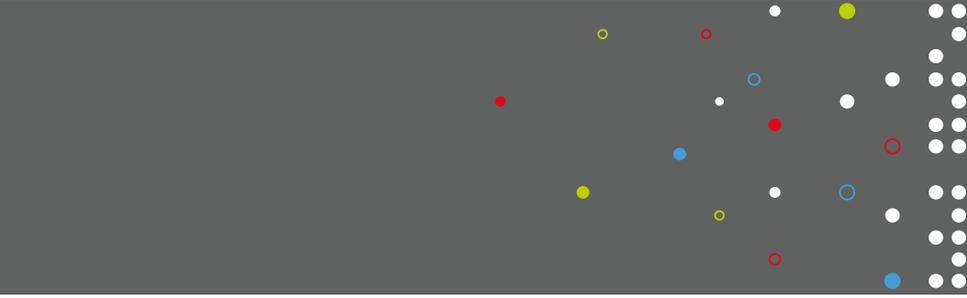
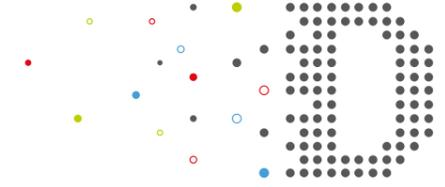

DLD[®]
DOĞUŞLED LIGHTING DESIGN

Oteller, tarihi eserler, köprüler, fabrikalar, stadyumlar, AVM'ler, hastaneler ve okullar gibi içinde yaşadığımız binalara kimlik kazandırarak onları yaşayan ve nefes alan mekanlara dönüştüren DOĞUŞLED & AYDINLATMA ve PROJE; 2006 yılında kuruluşundan buyana hızla büyüyerek, Türkiye'nin başarılı aydınlatma firması olma gururuyla yurt içi ve yurtdışındaki prestijli projelere imza atmaya devam etmektedir.

DOĞUŞLED & AYDINLATMA ve PROJE "Dünyaya açılmak için üretmek lazım" prensibinden yola çıkarak, heyecanını hiç kaybetmeden yenilikçi ürünler üreten uzman mühendis kadrosuyla; EN İYİ PROJE, EN İYİ ÜRÜN, EN İYİ KONTROL ilkesini benimsemektedir.

DOĞUŞLED & AYDINLATMA ve PROJE olarak amacımız; sürekli kendini yenileyen ARGE mizle projeye uygun ürünler sunarak, mekanların mimari yapısıyla bütünleşen tasarımlarımızı, zamanında ve kusursuz olarak hayata geçirmektir.

LED'Lİ SOKAK AYDINLATMA ARMATÜRLERİ



LED'Lİ PROJEKTÖRLER



LED'Lİ DIŐ MEKAN ARMATÜRLERİ



ENDÜSTRİYEL ALANLAR



ENDÜSTRİYEL ALANLAR



MİMARİ AYDINLATMA



ORTAK ALAN AYDINLATMALARI

İÇ MEKAN ÜRÜNLER

SIVA ALTI ARMATÜRLER



SIVA ÜSTÜ ARMATÜRLER



SARKIT ARMATÜRLER

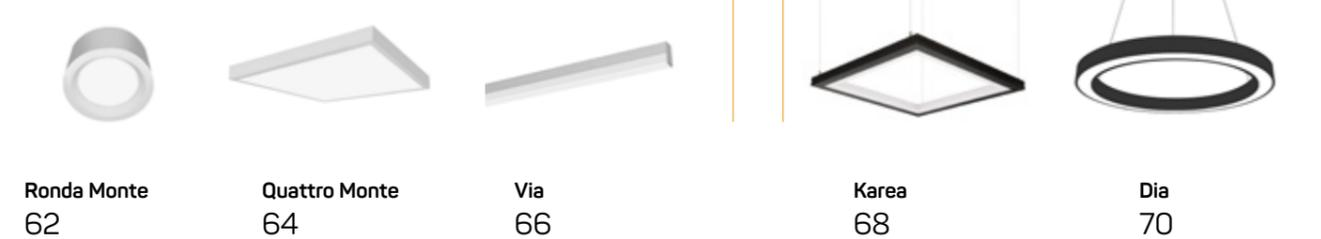

Road [5]

LED'Lİ YOL AYDINLATMA SİSTEMLERİ

Şehirler için yeni nesil LED aydınlatma serisi Road [5]. Maksimum enerji tasarrufu ile peyzaj alanlarında, cadde ve sokaklarda ideal aydınlatma çözümleri sunmaktadır.



Road [5] - Mini

Ürün Kodu	Modül Sayısı	Renk Sıcaklığı	LED Akım	Sistem Gücü	Nominal Flux (lm)	Lümen Çıkışı (lm)	Ağırlık (kg)
GWR 5131	1 (1x3 LED)	4000 K (CRI 70)	0.35 A	14 W	1560	1310	6.4
GWR 5271	1 (1x3 LED)	4000 K (CRI 70)	0.7 A	27 W	2350	1900	6.4
GWR 5711	1 (1x3 LED)	4000 K (CRI 70)	1 A	38 W	4770	3840	6.4
GWR 5772	2 (2x3 LED)	4000 K (CRI 70)	0.7 A	53 W	6240	5240	6.6
GWR 5712	2 (2x3 LED)	4000 K (CRI 70)	1 A	76 W	9540	7680	6.6

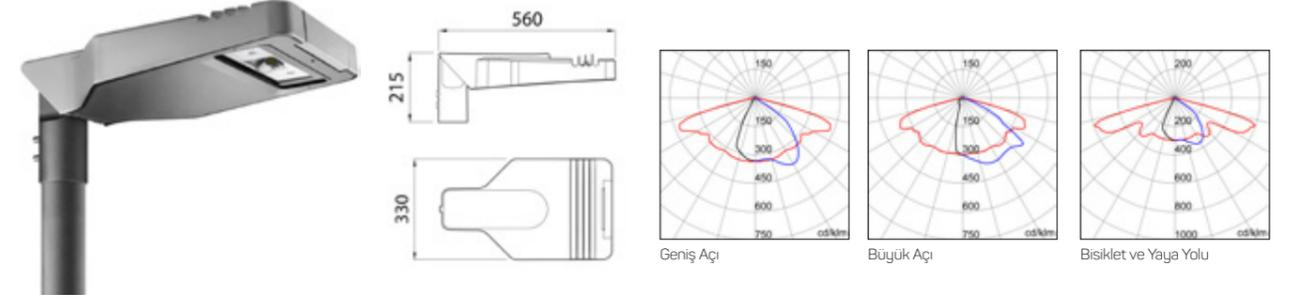

Road [5] - Medium

Ürün Kodu	Modül Sayısı	Renk Sıcaklığı	LED Akım	Sistem Gücü	Nominal flux (lm)	Lümen çıkışı (lm)	Ağırlık (kg)
GWR 5273	3 (3x3 LED)	4000 K (CRI 70)	0.7 A	79 W	9360	7860	8
GWR 5774	4 (4x3 LED)	4000 K (CRI 70)	0.7 A	106 W	12480	10480	8.4
GWR 5713	3 (3x3 LED)	4000 K (CRI 70)	1 A	113 W	14310	11520	8
GWR 5775	5 (5x3 LED)	4000 K (CRI 70)	0.7 A	132 W	15600	13100	8.8
GWR 5714	4 (4x3 LED)	4000 K (CRI 70)	1 A	151 W	19080	15360	8.4
GWR 5715	5 (5x3 LED)	4000 K (CRI 70)	0.85 A	159 W	21230	17090	8.8
GWR 5716	6 (6x3 LED)	4000 K (CRI 70)	0.85 A	185 W	24330	19580	9.1

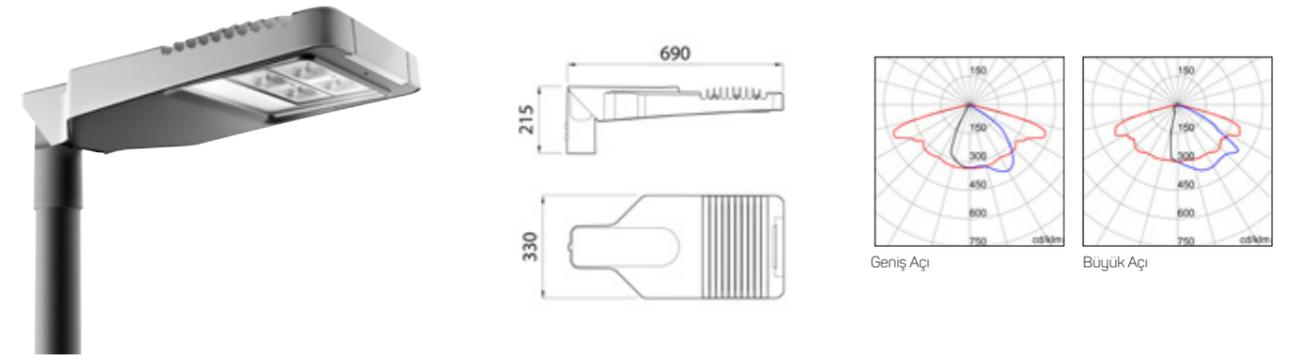

Optik Özellikler
> Geniş Açı
> Büyük Açı
> Bisiklet ve Yaya Yolu

Gövde Rengi
> Grafite Gri / Alüminyum

Not

Talep üzerine 3000K (-30K) veya 5700K (-57K) LED'li veya daha düşük LED akımlı modeller yapılmaktadır. LED teknolojilerindeki sürekli değişiklikler nedeniyle, teknik veriler değişiklik gösterebilir.

Street [O₃]

LED'Lİ YOL AYDINLATMA SİSTEMLERİ

Street [O₃] yol aydınlatmalarında, geniş alanlar, otopark ve sokak aydınlatmalarında üstün optik çıkış özelliği sayesinde mükemmel sonuçlar sunar.



Street [O₃]

Ürün Kodu	Modül Sayısı	Renk Sıcaklığı	Sistem Gücü	Nominal Flux (lm)	Lümen Çıkışı (lm)	Ağırlık (kg)
GW 87 410	1 (1x16 LED)	4000 K (CRI 70)	37 W	4140	3470	8.5
GW 87 411	2 (2x16 LED)	4000 K (CRI 70)	68 W	8050	6760	9.1
GW 87 412	3 (3x16 LED)	4000 K (CRI 70)	99 W	11740	9860	9.6
GW 87 414	5 (5x16 LED)	4000 K (CRI 70)	127 W	16360	13740	10.9
GW 87 413	4 (4x16 LED)	4000 K (CRI 70)	131 W	15370	12900	10.3

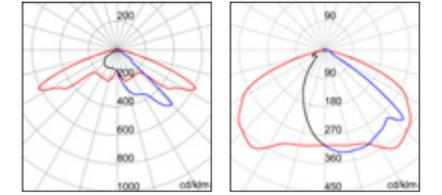
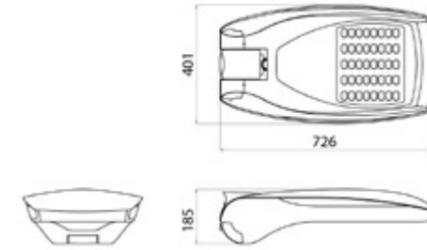

ST1 Optik ST2 Optik

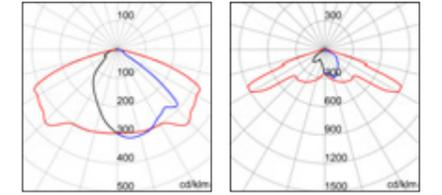

ST3 Optik Bisiklet ve Yaya Yolu

Optik Özellikler

- > ST1 Optik
- > ST2 Optik
- > ST3 Optik
- > Bisiklet ve Yaya Yolu

Gövde Rengi

- > Grafite Gri / Alüminyum

Not

Talep üzerine driver farklı LED akımları için ayarlanabilir.
LED teknolojilerindeki sürekli değişiklikler nedeniyle, teknik veriler değişiklik gösterebilir.

Smart [PRO] 2.0

LED'Lİ PROJEKTÖR SİSTEMLERİ

Smart[PRO] 2.0 profesyonellere özel yeni LED projektör serisidir. Yüksek aydınlatma performansı ile spor tesisleri ve geniş açık alanlar için idealdir.



Smart [PRO] 2.0

Ürün Kodu	Modül	Renk Sıcaklığı (CRI 70)	Sistem Gücü	Nominal Flux (lm)	Lümen Çıkışı (lm)	Ağırlık (kg)
GWP 2174 BS	1 Modül	4000 K	165 W	24000	21000	5.7
GWP 2274 BS	2 Modül	4000 K	330 W	48000	41000	13
GWP 2474 BS	2+2 Modül	4000 K	660 W	96000	82000	15

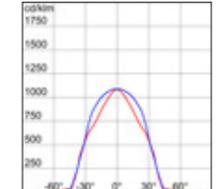
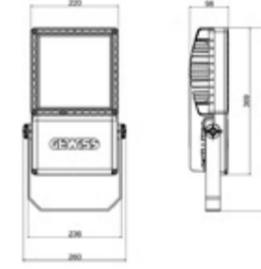

S1 Optic (Simetrik 1)

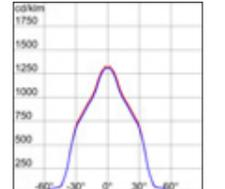

S2 Optic (Simetrik 2)

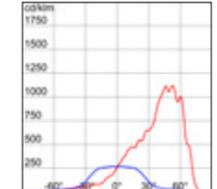
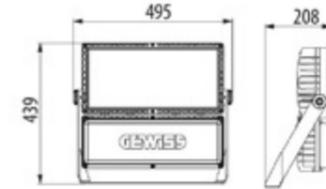

A1 Optic (Asimetrik 1)

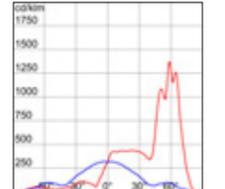

A2 Optic (Asimetrik 2)

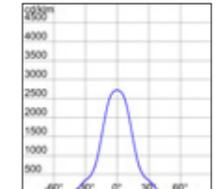
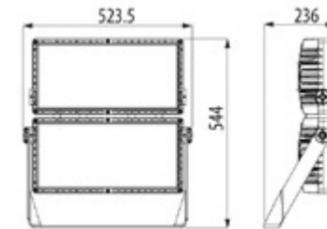

C1 Optic (Circular 1)

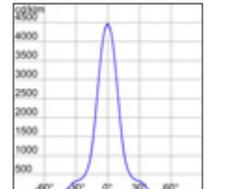

C2 Optic (Circular 2)

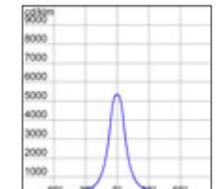

C3 Optic (Circular 3)

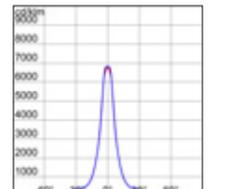

C4 Optic (Circular 4)

Optik Özellikler

- > S1 Optik (Simetrik 1)
- > S2 Optik (Simetrik 2)
- > A1 Optik (Asimetrik 1)
- > A2 Optik (Asimetrik 2)
- > C1 Optik (Circular 1)
- > C2 Optik (Circular 2)
- > C3 Optik (Circular 3)
- > C4 Optik (Circular 4)

Gövde Rengi

- > Grafite Grişi / Alüminyum

Not

Talep üzerine driver farklı LED akımları için ayarlanabilir. LED teknolojilerindeki sürekli değişiklikler nedeniyle, teknik veriler değişiklik gösterebilir.

Elia FL

LED'Lİ PROJEKTÖR SİSTEMLERİ

Elia FL ailenin yeni LED projektörü. Hızlı montaj yüksek aydınlatma performansı ile 5 yıl garantili.

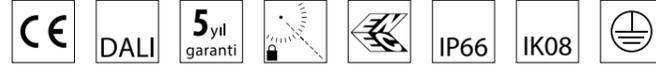

Elia FL

Ürün Kodu	Optik	Renk Sıcaklığı (CRI 70)	Sistem Gücü	Lümen Çıkışı (lm)	Ağırlık (kg)
GWF 1100GH840	Asimetrik - 30° - 60°	4000 K	50 W	6600	2.6
GWF 1100MH840	Asimetrik - 30° - 60°	4000 K	100 W	13400	3.9
GWF 1100QH840	Asimetrik - 30° - 60°	4000 K	150 W	20400	3.9
GWF 1100VH840	Asimetrik - 30° - 60°	4000 K	200 W	27100	3.9

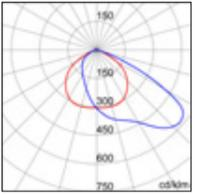
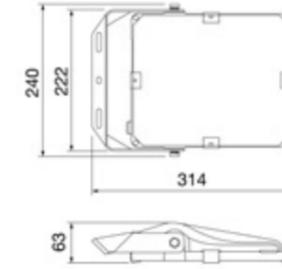

Asimetrik

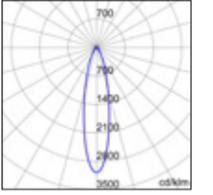

Optik 30°

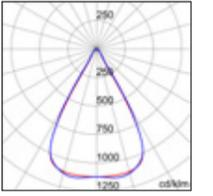

Optik 60°

Optik Özellikler

- > Asimetrik
- > 30°
- > 60°

Gövde Rengi

- > Siyah / Alüminyum

Not

Talep üzerine driver farklı LED akımları için ayarlanabilir.
LED teknolojilerindeki sürekli değişiklikler nedeniyle, teknik veriler değişiklik gösterebilir.

Esalite FL

DÜŞÜK VE ORTA GÜÇTE LED'Lİ PROJKTÖR SİSTEMLERİ

Açık ve kapalı alanlar için mükemmel performans ve yüksek kalite projektör serisi.

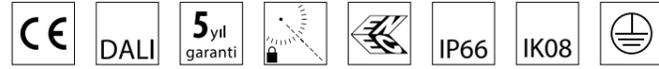

Esalite FL

Ürün Kodu	Açı	Renk Sıcaklığı (CRI 80)	Sistem Gücü	Nominal Flux (lm)	Lümen Çıkışı (lm)	Ağırlık (kg)
GWS 6425GD	Eliptik	4000 K	112 W	15000	11900	9.5
GWS 6435GD	Eliptik	4000 K	125 W	17000	13600	9.5
GWS 6445GD	Eliptik	4000 K	148 W	20000	15800	9.5
GWS 6455GD	Eliptik	4000 K	210 W	29000	22200	13.7

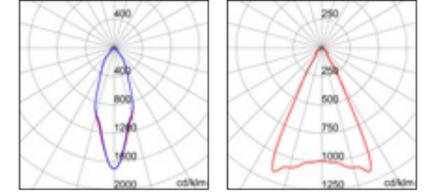
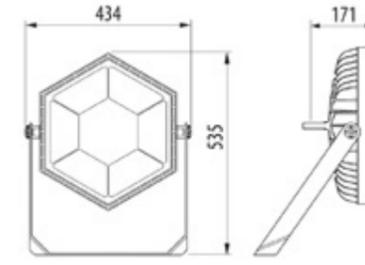

Optik 30° Optik 60°

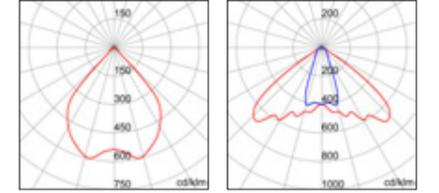
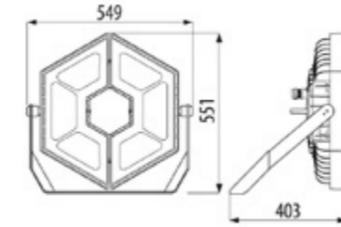
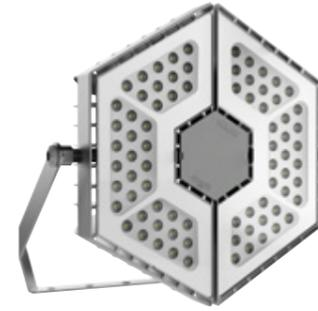

Optik 90° Eliptik Optik

Optik Özellikler

- > Optik 30°
- > Optik 60°
- > Optik 90°
- > Eliptik Optik

Gövde Rengi

- > Grafite Gri / Alüminyum

Not

Talep üzerine driver farklı LED akımları için ayarlanabilir.
LED teknolojilerindeki sürekli değişiklikler nedeniyle, teknik veriler değişiklik gösterebilir.

Esalite PL

YEŞİL ALANLAR İÇİN LED'Lİ PROJKTÖR SİSTEMLERİ

Açık ve kapalı alanlar için uzun ömürlü güvenilir ve üstün performans.

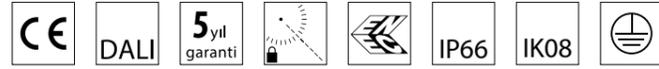

Esalite PL

Ürün Kodu	Açı	Renk Sıcaklığı (CRI 80)	Sistem Gücü	Nominal Flux (lm)	Lümen Çıkışı (lm)	Ağırlık (kg)
GWS 6515BD	Eliptik	4000 K	52 W	7200	5800	3.8
GWS 6525BD	Eliptik	4000 K	112 W	15000	11900	8.5
GWS 6535BD	Eliptik	4000 K	125 W	17000	13600	8.5
GWS 6545BD	Eliptik	4000 K	148 W	20000	15800	8.5

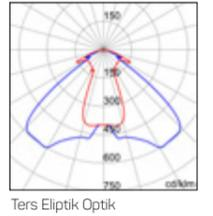
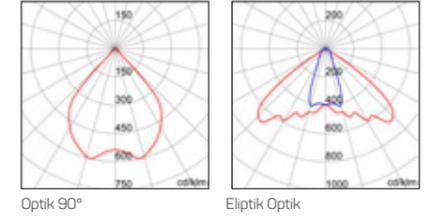
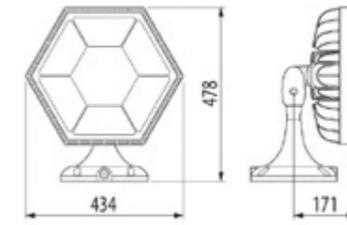
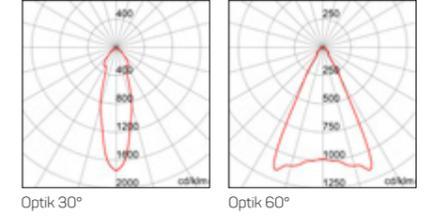
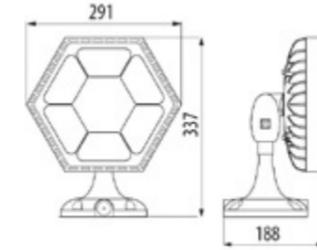

Optik Özellikler

- > Optik 30°
- > Optik 60°
- > Optik 90°
- > Eliptik Optik
- > Ters Eliptik Optik

Gövde Rengi

- > Grafite Gri / Alüminyum
- > Blue Green Colour / Alüminyum

Not

Talep üzerine driver farklı LED akımları için ayarlanabilir.
LED teknolojilerindeki sürekli değişiklikler nedeniyle, teknik veriler değişiklik gösterebilir.

www.dld.com.tr

www.dogusled.com.tr

Urban [O₃]

KENTSEL AYDINLATMA SİSTEMLERİ

Farklı kurulum konfigürasyonları ve mükemmel birleşimi ile modüler bir kentsel aydınlatma armatürü.



Urban [O₃]

Ürün Kodu	Renk Sıcaklığı (CRI 70)	Sistem Gücü	Nominal Flux (lm)	Lümen Çıkışı (lm)	Ağırlık (kg)	
GW 87 607	3 (3x16 LED)	4000 K	81 W	10230	8590	10.3
GW 87 608	4 (4x16 LED)	4000 K	105 W	13400	11240	11

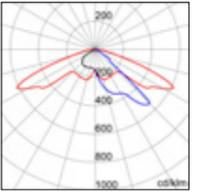
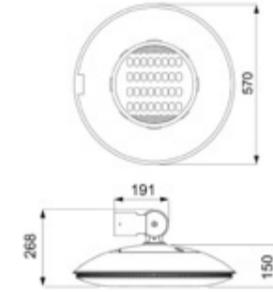

Sokak Optik

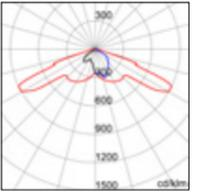

Yaya Optik

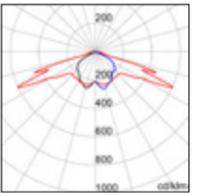

Simetrik Optik

Optik Özellikler

- > Sokak Optik
- > Yaya Optik
- > Simetrik Optik

Gövde Rengi

- > Grafite Gri / Alüminyum

Not

Talep üzerine driver farklı LED akımları için ayarlanabilir.
LED teknolojilerindeki sürekli değişiklikler nedeniyle, teknik veriler değişiklik gösterebilir.

Dedalo

MİMARİ PROJEKTÖRLER

Mimari kullanımlarda, iç ve dış mekân uygulamaları için en iyi çözüm.

Dedalo

Ürün Kodu	Optik	Renk Sıcaklığı (CRI 80)	Sistem Gücü	Nominal Flux (lm)	Lümen Çıkışı (lm)
GW 84 183	Circular 20°	4000 K	20 W	2230	1540
GW 84 184	Circular 45°	4000 K	20 W	2230	1650

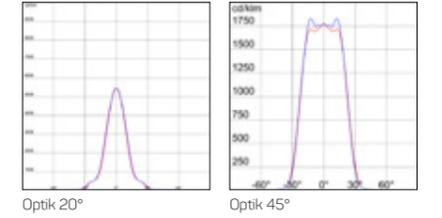
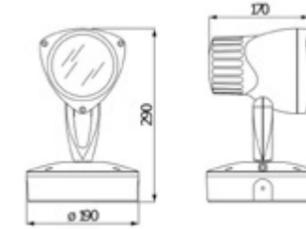

Optik Özellikler
> Optik 20°
> Optik 45°

Gövde Rengi
> Grafite Gri
> Mavi Gri

Not

Talep üzerine driver farklı LED akımları için ayarlanabilir.
LED teknolojilerindeki sürekli değişiklikler nedeniyle, teknik veriler değişiklik gösterebilir.

Point

PEYZAJ ALANLARI

Yerleşim alanları için korumalı optiği olan bir bahçe ve peyzaj aydınlatma serisi.



Point

Ürün Kodu	Renk Sıcaklığı	Sistem Gücü	Işık Kaynağı	Uzunluk (mm)	Ağırlık (kg)
GW 82011G	3000 K	4 W	E14	473	0.9
GW 82016G	3000 K	6 W	E27	550	1.5
GW 82018G	3000 K	6 W	E27	780	2

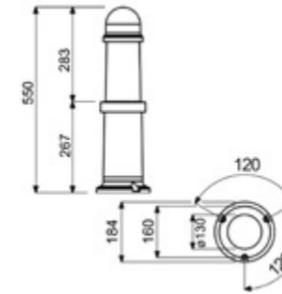
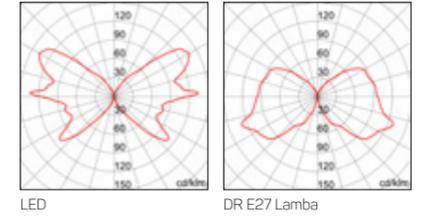
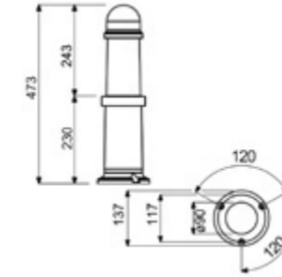

Optik Özellikler
> Simetrik

Gövde Rengi
> Grafite Gri / PMMA / PC
> Blue Green / PMMA / PC

Not
Talep üzerine driver farklı LED akımları için ayarlanabilir.
LED teknolojilerindeki sürekli değişiklikler nedeniyle, teknik veriler değişiklik gösterebilir.

Extro

ÇOK FONKSİYONLU AYDINLATMA SİSTENLERİ

Polikarbonat gövdeli mesken ve kentsel alanlar için çok fonksiyonlu aydınlatma armatürü.



Extro

Ürün Kodu	Sistem Gücü	Işık Kaynağı	Renk Sıcaklığı	Nominal Flux (lm)	Lümen Çıkışı (lm)	Ağırlık (kg)
GW S2 401	13 W	LED	4000 K (CRI 80)	1200	1000	2
GW S2 402	26 W	LED	4000 K (CRI 80)	2400	1950	2.4

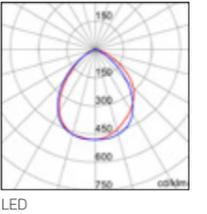
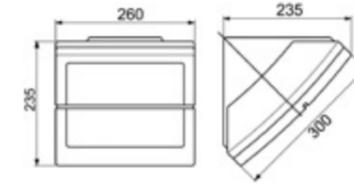

Ürün Kodu	Malzeme	Yükseklik mm
GW82292	Alüminyum	250 (Maksimum 1300mm)



Ürün Kodu	Malzeme	Boyutlar mm
GW82297	Alüminyum	300x202x315 (Maksimum 1300mm)

Optik Özellikler
> 13 - 26 W LED
> Hareket Sensörü

Gövde Rengi
> Grafite Gri
> Blue Green

Not

Talep üzerine driver farklı LED akımları için ayarlanabilir.
LED teknolojilerindeki sürekli değişiklikler nedeniyle, teknik veriler değişiklik gösterebilir.

Esalite HB

ENDÜSTRİYEL AYDINLATMA SİSTEMLERİ

Açık ve kapalı alanlar için mükemmel performans ve yüksek kaliteli projektör serisi.

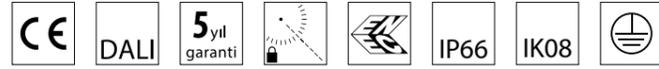

Esalite HB

Ürün Kodu	Açı	Renk Sıcaklığı (CRI 80)	Sistem Gücü	Nominal Flux (lm)	Lümen Çıkışı (lm)	Ağırlık (kg)
GWS 6315 GD	Eliptik	4000 K	52 W	7200	5800	3.3
GWS 6325 GD	Eliptik	4000 K	112 W	15000	11900	7.5
GWS 6335 GD	Eliptik	4000 K	125 W	17000	13600	7.5
GWS 6345 GD	Eliptik	4000 K	148 W	20000	15800	7.5
GWS 6355 GD	Eliptik	4000 K	210 W	29000	22200	11.2
GWS 6385 GD	Eliptik	4000 K	420 W	63000	44500	22.5

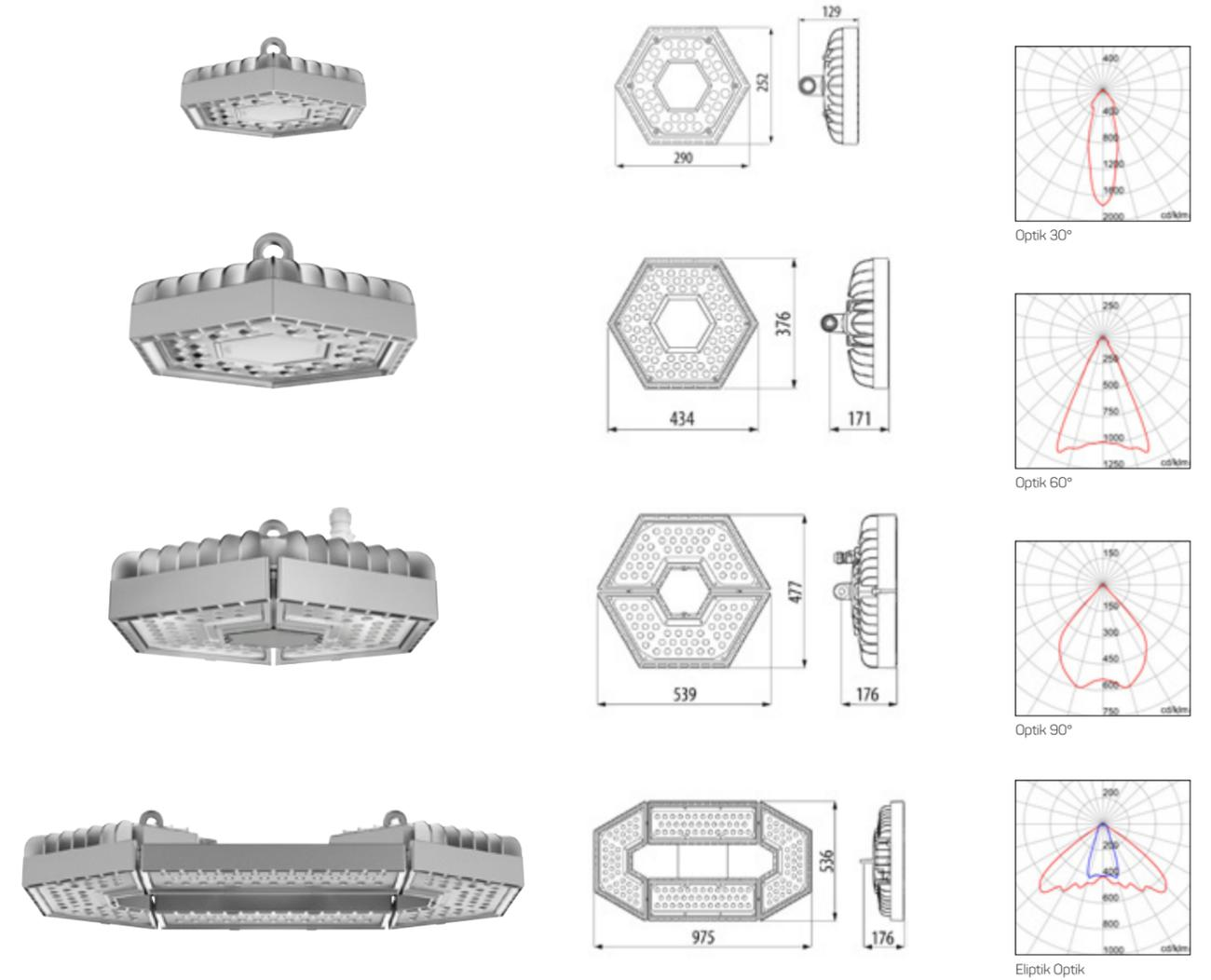

Optik Özellikler

- > Optik 30°
- > Optik 60°
- > Optik 90°
- > Eliptik Optik

Gövde Rengi

- > Grafite Grişi
- > Mavi Yeşil

Not

Talep üzerine driver farklı LED akımları için ayarlanabilir.
LED teknolojilerindeki sürekli değişiklikler nedeniyle, teknik veriler değişiklik gösterebilir.

Smart [3]

LED'Lİ SU GEÇİRMEZ ARMATÜRLER

Yeni LED teknolojisi ile son derece düşük enerji tüketimi, yüksek darbe dayanımı, hızlı ve kolay montaj özelliği.

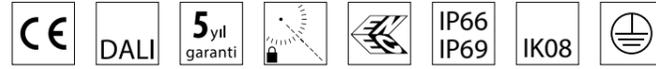

Smart [3]

Ürün Kodu	Uzunluk (mm)	Renk Sıcaklığı (CRI 80)	Sistem Gücü	Nominal Flux (lm)	Lümen Çıkışı (lm)	Ağırlık (kg)
GW S3 118 T	800	4000 K	15 W	2100	1700	1.5
GW S3 136 T	1200	4000 K	20 W	2900	2500	2
GW S3 158 T	1600	4000 K	26 W	3700	3400	2.5
GW S3 218 T	800	4000 K	27 W	3500	3400	1.5
GW S3 236 T	1200	4000 K	40 W	5500	4900	2
GW S3 258 T	1600	4000 K	50 W	6900	6500	2.5

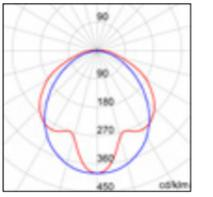
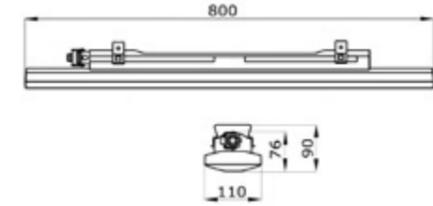

Transparan Kaplama

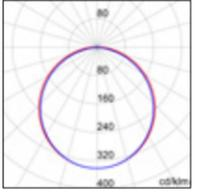
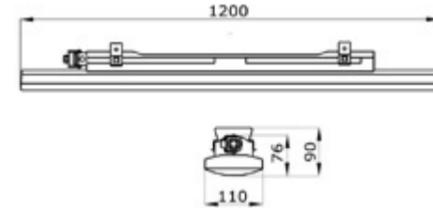

Opal Kaplama

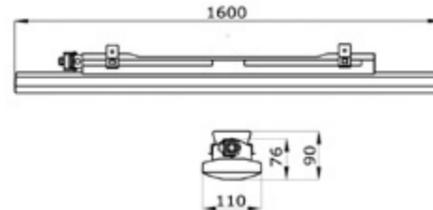

Optik Özellikler

- > Opal Kaplama
- > Transparan Kaplama

Gövde Rengi

- > Gri RAL 7035

Teknik Özellikler

- > 3 Saat Kit Opsiyonu
- > Dali Opsiyonu

Not

Talep üzerine driver farklı LED akımları için ayarlanabilir.
LED teknolojilerindeki sürekli değişiklikler nedeniyle, teknik veriler değişiklik gösterebilir.

Smart [3] C

LED'Lİ SU GEÇİRMEZ ARMATÜRLER

Yeni LED teknolojisi ile son derece düşük enerji tüketimi, yüksek darbe dayanımı, hızlı ve kolay montaj özelliği.



Smart [3] C

Ürün Kodu	Uzunluk (mm)	Renk Sıcaklığı (CRI 80)	Sistem Gücü	Nominal Flux (lm)	Lümen Çıkışı (lm)	Ağırlık (kg)
GW S3 236 TC	800	4000 K	35 W	4300	4000	1.5
GW S3 258 TC	1200	4000 K	56 W	6900	6700	2

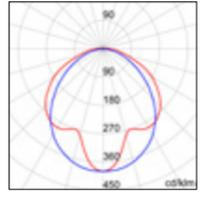
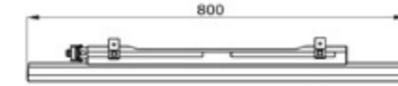

Transparan Kaplama

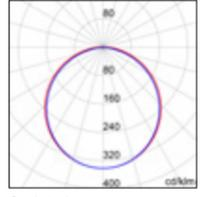
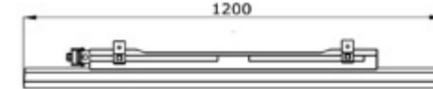

Opal Kaplama

Optik Özellikler
> Transparan Kaplama
> Opal Kaplama

Gövde Rengi
> Gri RAL 7035

Not

Talep üzerine driver farklı LED akımları için ayarlanabilir.
LED teknolojilerindeki sürekli değişiklikler nedeniyle, teknik veriler değişiklik gösterebilir.

Smart [3] S

LED'Lİ SU GEÇİRMEZ ARMATÜRLER

Yeni LED teknolojisi ile son derece düşük enerji tüketimi, yüksek darbe dayanımı, hızlı ve kolay montaj özelliği.



Smart [3] S

Ürün Kodu	Uzunluk (mm)	Renk Sıcaklığı (CRI 80)	Sistem Gücü	Nominal Flux (lm)	Lümen Çıkışı (lm)	Ağırlık (kg)
GW S3 280 TS	1600	4000 K	67 W	8600	8200	2.5

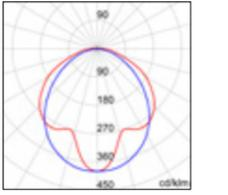
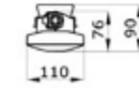
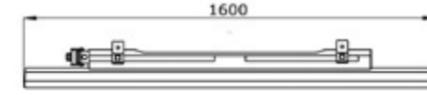

Transparan Kaplama

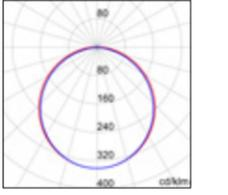

Opal Kaplama

Optik Özellikler
> Transparan Kaplama
> Opal Kaplama

Gövde Rengi
> Gri RAL 7035

Not

Talep üzerine driver farklı LED akımları için ayarlanabilir.
LED teknolojilerindeki sürekli değişiklikler nedeniyle, teknik veriler değişiklik gösterebilir.

Smart [4] 2.0 LB-HB

ENDÜSTRİYEL AYDINLATMA SİSTEMLERİ

Verimli optik çözümü sayesinde Smart [4] 2.0 serisi mükemmel aydınlatmayı garanti eder.



Smart [4] 2.0 LB-HB

Ürün Kodu	Renk Sıcaklığı (CRI 80)	Sistem Gücü	Nominal Flux (lm)	Lümen Çıkışı (lm)	Ağırlık (kg)
GW S4 004 GS	4000 K	25 W	2960	2600	1.8
GW S4 014 GS	4000 K	50 W	5910	5210	3
GW S4 034 GS	4000 K	60 W	7120	6510	3.2
GW S4 044 GS	4000 K	97 W	11810	10420	5.3
GW S4 054 GS	4000 K	118 W	14280	13020	6
GW S4 064 GS	4000 K	194 W	23630	20830	12
GW S4 074 GS	4000 K	236 W	28480	26040	13



GW S4 004 GS



GW S4 014 GS



GW S4 034 GS

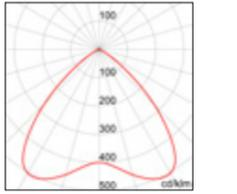
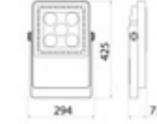

Diffused 100°



GW S4 044 GS

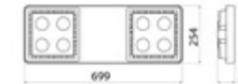

GW S4 054 GS

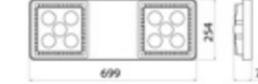

GW S4 064 GS

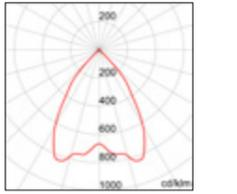
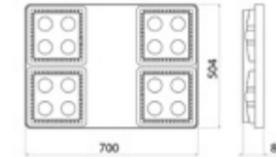

Medium 60°

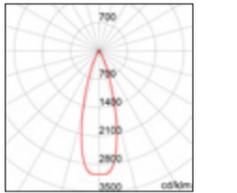

Restricted 30°

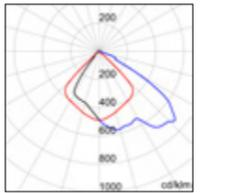

Asimetrik

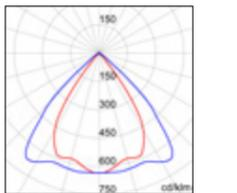

Elliptical

Optik Özellikler
> Diffused 100°
> Medium 60°
> Restricted 30°
> Asymmetrical
> Elliptical

Gövde Rengi
> Grey RAL 7037

Teknik Özellikler
> Dali Opsiyonu
> 3 Saat Kit Opsiyonu

Not

Talep üzerine driver farklı LED akımları için ayarlanabilir.
LED teknolojilerindeki sürekli değişiklikler nedeniyle, teknik veriler değişiklik gösterebilir.

Smart [4] 2.1 HLO

ENDÜSTRİYEL AYDINLATMA SİSTEMLERİ

Verimli optik çözümü sayesinde Smart [4] 2.0 serisi mükemmel aydınlatmayı garanti eder.



Smart [4] 2.1 HLO

Ürün Kodu	Renk Sıcaklığı (CRI 80)	Sistem Gücü	Nominal Flux (lm)	Lümen Çıkışı (lm)	Ağırlık (kg)
GW S4 234 GS	4000 K	70 W	8400	8000	3.2
GW S4 244 GS	4000 K	112 W	13440	12800	5.3
GW S4 254 GS	4000 K	140 W	16800	16000	6
GW S4 264 GS	4000 K	225 W	26880	25600	12
GW S4 274 GS	4000 K	280 W	33600	32000	13



GW S4 234 GS



GW S4 244 GS



GW S4 254 GS

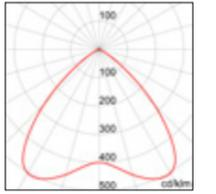

Diffused 100°

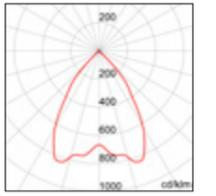
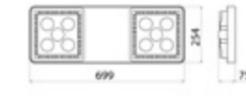
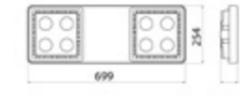
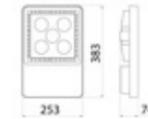

Medium 60°



GW S4 264 GS



GW S4 274 GS

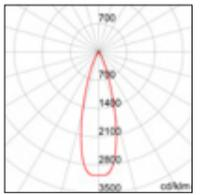

Restricted 30°

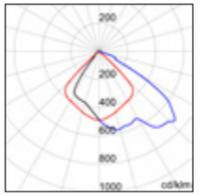
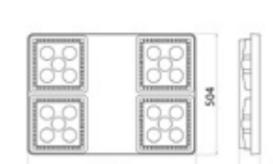
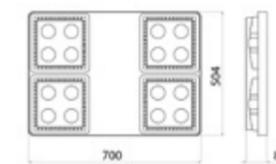

Asimetric

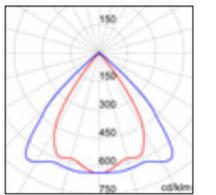

Elliptical

Optik Özellikler

- > Diffused 100°
- > Medium 60°
- > Restricted 30°
- > Asymmetrical
- > Elliptical

Gövde Rengi

- > Grey RAL 7037

Teknik Özellikler

- > Dali Opsiyonu
- > 3 Saat Kit Opsiyonu

Not

Talep üzerine driver farklı LED akımları için ayarlanabilir.
LED teknolojilerindeki sürekli değişiklikler nedeniyle, teknik veriler değişiklik gösterebilir.

Elia HL

ENDÜSTRİYEL AYDINLATMA SİSTEMLERİ

Verimli optik çözümü sayesinde Elia HL mükemmel aydınlatmayı garanti eder.

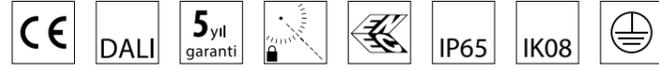

Elia HL

Ürün Kodu	Optik	Renk Sıcaklığı (CRI 80)	Sistem Gücü	Lümen Çıkışı (lm)	Ağırlık (kg)
GWF 1000 MM840	60° - 90° - 120°	4000 K	120 W	17000	3.9
GWF 1001 QM840	60° - 90° - 120°	4000 K	200 W	28000	4.2

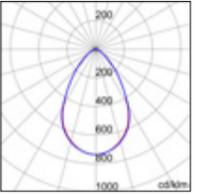
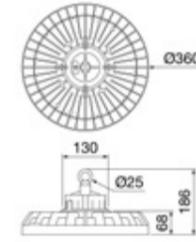

Optik 60°

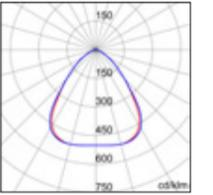

Optik 90°

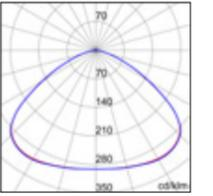

Optik 120°

Optik Özellikler
> 60°
> 90°
> 120°

Gövde Rengi
> Siyah

Not

Talep üzerine driver farklı LED akımları için ayarlanabilir.
LED teknolojilerindeki sürekli değişiklikler nedeniyle, teknik veriler değişiklik gösterebilir.

Elia WL

LED'Lİ SU GEÇİRMEZ ARMATÜRLER

Yeni LED teknolojisi ile son derece düşük enerji tüketimi, yüksek darbe dayanımı, hızlı ve kolay montaj.



Elia WL

Ürün Kodu	Uzunluk (mm)	Renk Sıcaklığı (CRI 80)	Sistem Gücü	Lümen Çıktısı (lm)	Ağırlık (kg)
GWS 2336P	1200	4000 K	37 W	4500	1.7
GWS 2336PE	1200	4000 K	42 W	4500	2.7
GWS 2358P	1500	4000 K	47 W	5700	2
GWS 2358PE	1500	4000 K	52 W	5700	3

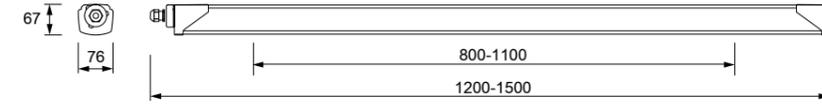
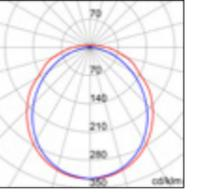

Optik Özellikler
> Opal Kaplama

Gövde Rengi
> Grafit Grişi

Not

Talep üzerine driver farklı LED akımları için ayarlanabilir.
LED teknolojilerindeki sürekli değişiklikler nedeniyle, teknik veriler değişiklik gösterebilir.

Bolla / Guscio

KOMPAKT TAVAN VE DUVAR ARMATÜRLERİ

Tamamen Polikarbonattan yapılmış, korumalı, kompakt, su geçirmez tavana monte aydınlatma armatürleri.



Bolla

Ürün Kodu	Sistem Gücü	Işık Kaynağı	Ağırlık (kg)
GW 80 761	60 W	E27	0.4
GW 80 763	100 W	E27	0.7

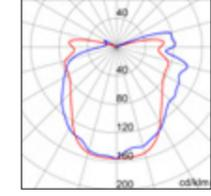
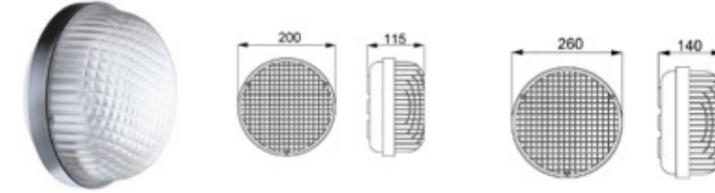

Bolla 200

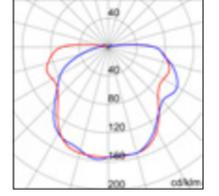

Bolla 260

Guscio

Ürün Kodu	Sistem Gücü	Işık Kaynağı	Ağırlık (kg)
GW 80 771	60 W	E27	0.5
GW 80 610	100 W	E27	0.9

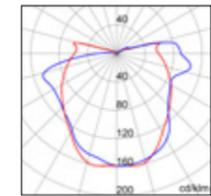
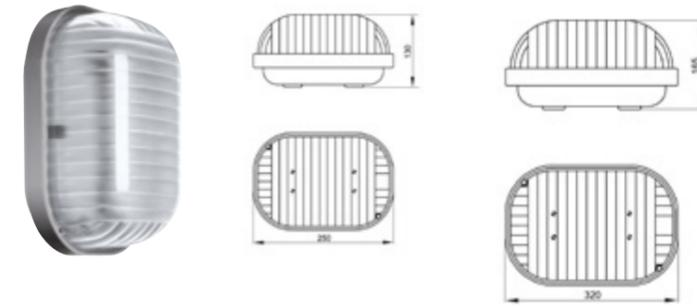

Guscio 250

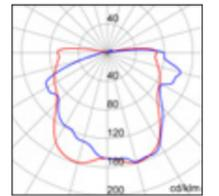

Guscio 320

Optik Özellikler
> Transparan Kaplama

Gövde Rengi
> Grafit Grişi / RAL 7035 Gri

Not

Talep üzerine driver farklı LED akımları için ayarlanabilir.
LED teknolojilerindeki sürekli değişiklikler nedeniyle, teknik veriler değişiklik gösterebilir.

www.dld.com.tr

www.dogusled.com.tr

Gemello

DIŐ MEKAN DEKORATİF AYDINLATMA ARMATÖRLERİ

- Enerji tasarruflu, uzun ömürlü
- Bakım gerektirmez
- Paslanmaz ön panel
- Alüminyum profil gövde



Gemello

Ürün Kodu	Sistem Gücü	Işık Kaynağı	Renk Sıcaklığı (CRI 80)	Ölçüler (mm)
DLD 212.06	1 x 10 W	LED	2670K - 10000K	A: 150 H: 220 Ø: 100
DLD 212.12	2 x 10 W	LED	2670K - 10000K	A: 150 H: 220 Ø: 100

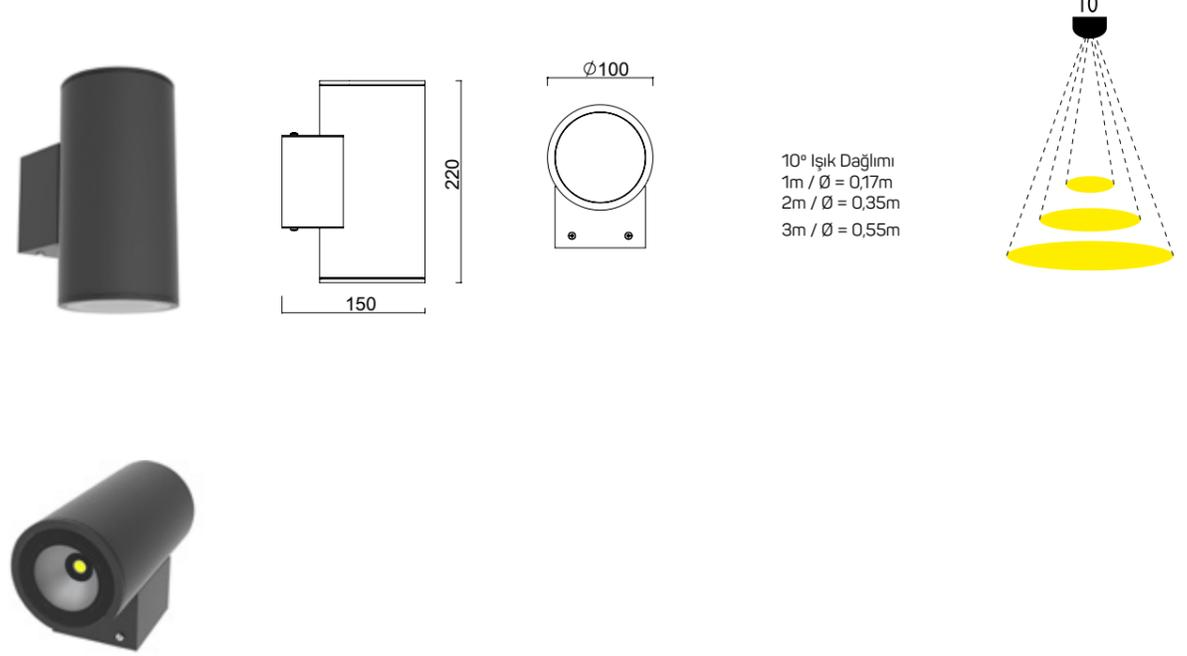

Optik Özellikler
> 24° - 36° - 45°

Gövde Rengi
> RAL Renk Seçenekleri

Not
Talep üzerine driver farklı LED akımları için ayarlanabilir.
LED teknolojilerindeki sürekli değişiklikler nedeniyle, teknik veriler değişiklik gösterebilir.

www.dld.com.tr

www.dogusled.com.tr

Stella

MİMARİ AYDINLATMA ARMATÜRLERİ

Yuvarlak hatları, düşük profili ve modüler yapısı sayesinde tüm projelerinizde avantaj sağlar.

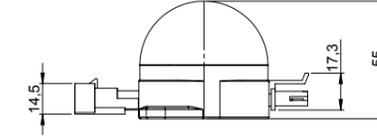
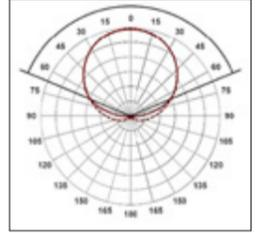
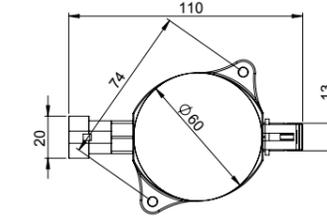

Teknik Özellikler

- > Polycarbon difüzör bakalit gövde
- > Opal Difüzör PC Lens
- > Modüler yapı
- > DALI
- > Değişken kapak sayesinde Sıcak Beyaz, Soğuk Beyaz, Kırmızı, Amber, Yeşil, Mor, Mavi

Gövde Rengi

- > Beyaz
- > Siyah

Not

Talep üzerine driver farklı LED akımları için ayarlanabilir.
LED teknolojilerindeki sürekli değişiklikler nedeniyle, teknik veriler değişiklik gösterebilir.

www.dld.com.tr

www.dogusled.com.tr

Elegante

DEKORATİF AYDINLATMA ARMATÜRLERİ

Tamamen dekoratif amaçlı, korumalı, kompakt, su geçirmez aydınlatma armatürleri.



Elegante

Ürün Kodu	Sistem Gücü	Işık Kaynağı	Lümen Çıkışı (lm)	Renk Sıcaklığı (CRI 80)	Ölçüler (mm)
DLD 10006012	12 W	60 LED SMD	1200	4000K	1000mm x 18,5mm x 12,7mm
DLD 10007014	14,4 W	70 LED SMD	1440	4000K	1000mm x 18,5mm x 12,7mm
DLD 100014412	12 W	144 LED SMD	1500	4000K	1000mm x 18,5mm x 12,7mm

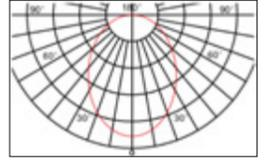
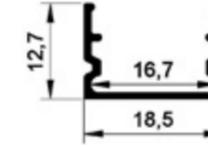

Optik Özellikler
> Simetrik
> Şeffaf Difüzör
> Opal Difüzör

Gövde Rengi
> RAL Renk Seçenekleri

Not
3000K-5000K ve RGB renk seçenekleride seçilebilir.
LED teknolojilerindeki sürekli değişiklikler nedeniyle, teknik veriler değişiklik gösterebilir.

Terra

DEKORATİF AYDINLATMA ARMATÜRLERİ

Tamamen dekoratif amaçlı, korumalı, kompakt, su geçirmez aydınlatma armatürleri.

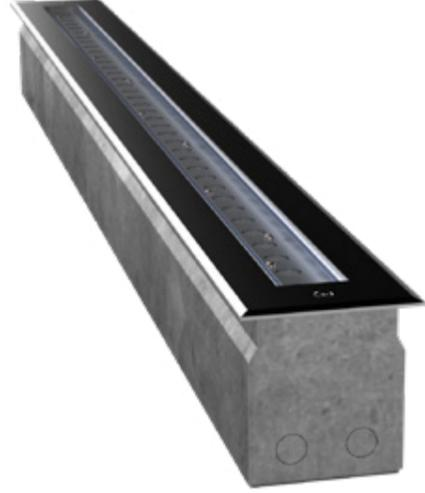

Terra

Ürün Kodu	Sistem Gücü	Lümen Çıkışı (lm)	Renk Sıcaklığı (CRI 80)	Ölçüler (mm)
DLD 3009	9W	945	4000K	351 x 101,5 x 105,5
DLD 60018	18W	1890	4000K	601 x 101,5 x 105,5
DLD 80027	27W	2835	4000K	851 x 101,5 x 105,5
DLD 100036	36W	3780	4000K	1101 x 101,5 x 105,5

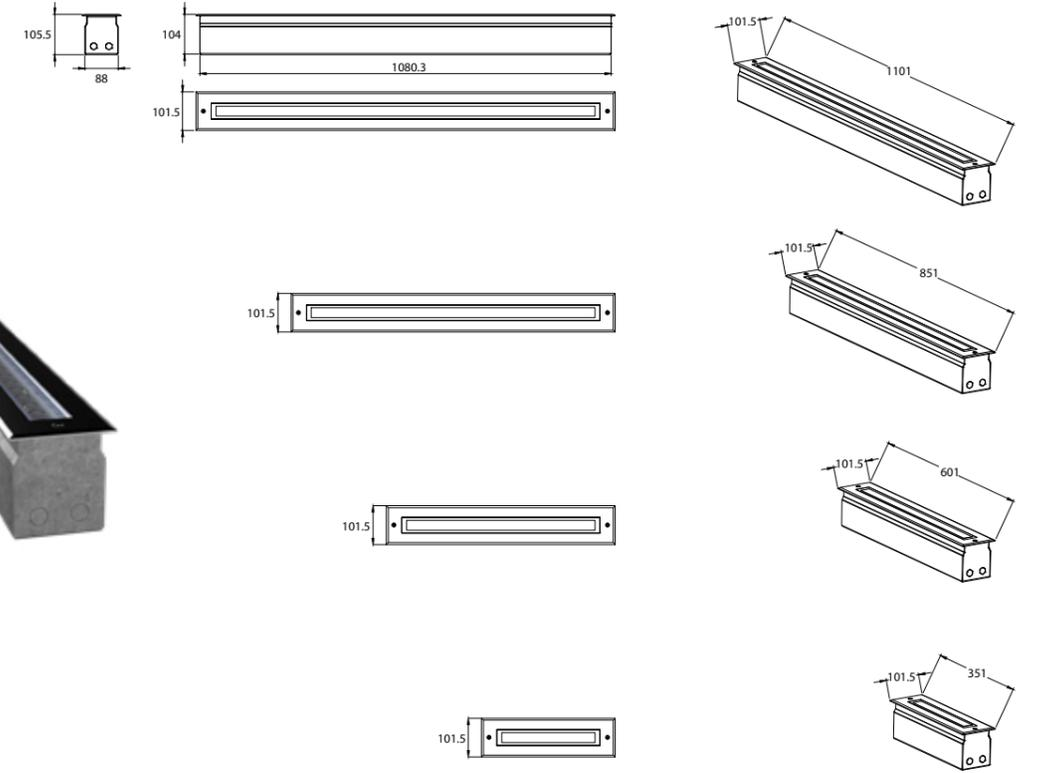
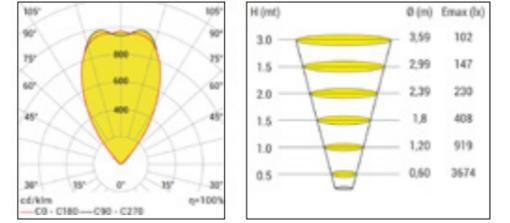

Optik Özellikler
> Simetrik
> 15° - 25° - 45°

Gövde Rengi
> RAL Renk Seçenekleri

Not
AMBER 3000K, 5700K, 6500K ve RGB renk seçenekleride seçilebilir.
LED teknolojilerindeki sürekli değişiklikler nedeniyle, teknik veriler değişiklik gösterebilir.

Powerfull

DEKORATİF AYDINLATMA ARMATÜRLERİ

Tamamen dekoratif amaçlı, korumalı, kompakt, su geçirmez aydınlatma armatürleri.



Powerfull

Ürün Kodu	Sistem Gücü	Lümen Çıkışı (lm)	Renk Sıcaklığı (CRI 80)	Ölçüler (mm)
DLD 2709	9W	945	4000K	270 x 61,6 x 58,2
DLD 52018	18W	1890	4000K	520 x 61,6 x 58,2
DLD 77027	27W	2835	4000K	770 x 61,6 x 58,2
DLD 102036	36W	3780	4000K	1020 x 61,6 x 58,2
DLD 127045	45W	4725	4000K	1270 x 61,6 x 58,2

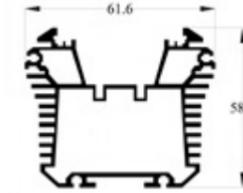
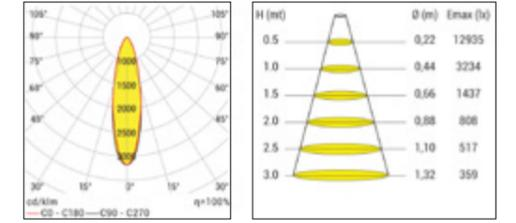

Optik Özellikler

- > Simetrik
- > 10° - 25° - 45° - 60°

Gövde Rengi

- > RAL Renk Seçenekleri

Not

RGB, AMBER, 3000K, 5700K, 6500K ve RGB renk seçenekleride seçilebilir.
LED teknolojilerindeki sürekli değişiklikler nedeniyle, teknik veriler değişiklik gösterebilir.



İÇ MEKAN

Ronda

SIVA ALTI ARMATÜRLER

Yapınıza değer katan şık ve kullanışlı tavana monte aydınlatma armatürleri.



Ronda

Ürün Kodu	Ölçüler (mm)	Renk Sıcaklığı (CRI 80)	Sistem Gücü	Lümen Çıkışı (lm)	Ağırlık (kg)
DLD 1 10321 0112 01	A1: 90 L1: 110 H: 50	4000 K	5 W	441	0.3
DLD 1 10321 0112 01	A1: 90 L1: 110 H: 50	4000 K	10 W	895	0.3
DLD 1 12321 0214 01	A1: 140 L1: 165 H: 54	4000 K	12 W	1223	0.6
DLD 1 15321 0214 01	A1: 140 L1: 165 H: 54	4000 K	15 W	1548	0.6
DLD 1 20321 0316 01	A1: 205 L1: 230 H: 62	4000 K	20 W	2286	0.8
DLD 1 30321 0316 01	A1: 205 L1: 230 H: 62	4000 K	30 W	3298	0.9

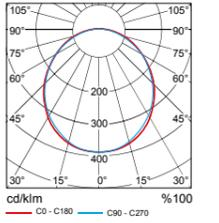
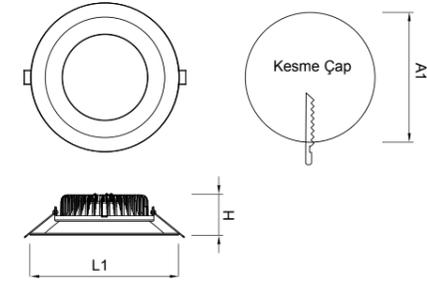

Teknik Özellikler

- > Alüminyum Enjeksiyon Gövde
- > Elektrostatik Toz Boyalı Metal Çerçeve
- > Homojen Aydınlatma
- > MacAdam 3 LED Renk Toleransı
- > DALI ve Acil Kit Seçenekleri

Gövde Rengi

- > RAL Renk Seçenekleri

Not

Talep üzerine driver farklı LED akımları için ayarlanabilir.
LED teknolojilerindeki sürekli değişiklikler nedeniyle, teknik veriler değişiklik gösterebilir.

Elia AL / DL

SIVA ALTI ARMATÜRLER

Yapılarına değer katan şık ve kullanışlı tavana monte aydınlatma armatürleri.

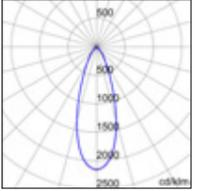
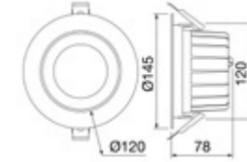

Elia AL

Ürün Kodu	Optik	Renk Sıcaklığı (CRI 80 - 90)	Sistem Gücü	Lümen Çıkışı (lm)
GWF 1410GG840	36°	4000 K	18 W	2030
GWF 1410GH840	60°	4000 K	18 W	2120
GWF 1410MG840	36°	4000 K	25 W	2700
GWF 1411MH840	60°	4000 K	25 W	2840

Elia DL

Ürün Kodu	Optik	Renk Sıcaklığı (CRI 80 - 90)	Sistem Gücü	Lümen Çıkışı (lm)
GWF 1510MA840	Geniş Açılı	4000 K	25 W	2600
GWF 1510QA840	Geniş Açılı	4000 K	35 W	3550

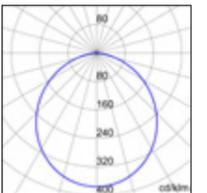
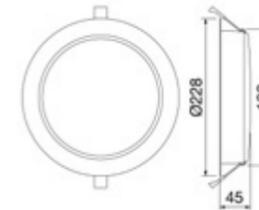

Teknik Özellikler

- > Ömür: 50.000 saat (L80 B50) T_q 25°
- > MacAdam 5 LED Renk Toleransı
- > URG: < 19
- > Çalışma Sıcaklığı [T_a]: -20° + 45°

Gövde Rengi

- > Beyaz

Not

Talep üzerine driver farklı LED akımları için ayarlanabilir.
LED teknolojilerindeki sürekli değişiklikler nedeniyle, teknik veriler değişiklik gösterebilir.

Quattro

SIVA ALTI ARMATÜRLER

Yapınıza değer katan şık ve kullanışlı tavana monte aydınlatma armatürleri.



Quattro

Ürün Kodu	Ölçüler (mm)	Renk Sıcaklığı (CRI 80)	Sistem Gücü	Lümen Çıkışı (lm)	Ağırlık (kg)
DLD 1 30251 U310	A1: 575 A2: 575 L1: 595 L2: 595 H: 58	4000 K	30 W	3150	2.9
DLD 1 60251 U510	A1: 575 A2: 575 L1: 595 L2: 595 H: 83	4000 K	38 W	3990	9.2
DLD 1 60251 U510	A1: 575 A2: 575 L1: 595 L2: 595 H: 83	4000 K	42 W	4410	9.2

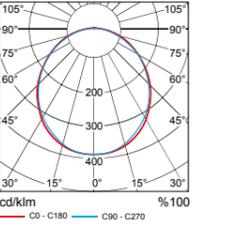
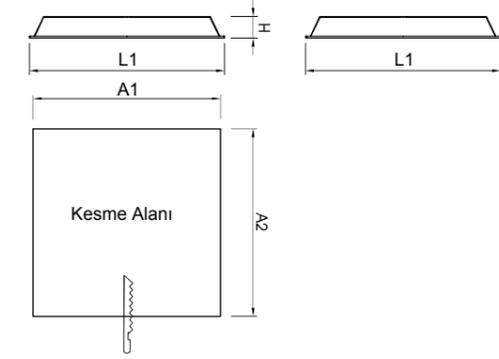

Teknik Özellikler

- > Polyester elektrostatik toz boyalı
- > Yüksek geçirgenlikli satine PMMA veya PS opal difüzör
- > Mikroprizmatik lens opsiyonu
- > Homojen aydınlatma
- > MacAdam 3 LED Renk Toleransı
- > DALI ve Acil Kit Seçenekleri

Gövde Rengi

- > Beyaz
- > RAL Renk Seçenekleri

Not

Talep üzerine driver farklı LED akımları için ayarlanabilir.
LED teknolojilerindeki sürekli değişiklikler nedeniyle, teknik veriler değişiklik gösterebilir.

Elia CL

SIVA ÜSTÜ VE SARKIT ARMATÜRLER

Yapınıza değer katan şık ve kullanışlı tavana monte aydınlatma armatürleri.



Elia CL

Ürün Kodu	Optik	Renk Sıcaklığı (CRI 80 - 90)	Sistem Gücü	Lümen Çıkışı (lm)
GWF 1310GA840	Opal	4000 K	12 W	1150
GWF 1310MA840	Opal	4000 K	25 W	2500



Teknik Özellikler

- > Ömür: 50.000 saat (L80 B50) T_q 25°
- > MacAdam 5 LED Renk Toleransı
- > CRI: 80
- > Çalışma sıcaklığı [T_a]: -20° + 45°

Gövde Rengi

- > Beyaz

Not

Talep üzerine driver farklı LED akımları için ayarlanabilir.
LED teknolojilerindeki sürekli değişiklikler nedeniyle, teknik veriler değişiklik gösterebilir.

Ronda Monte

SIVA ÜSTÜ VE SARKIT ARMATÜRLER

Yapınıza değer katan şık ve kullanışlı tavana monte aydınlatma armatürleri.



Ronda Monte

Ürün Kodu	Ölçüler (mm)	Renk Sıcaklığı (CRI 80)	Sistem Gücü	Lümen Çıkışı (lm)	Ağırlık (kg)
DLD 3 05321 0411 01	L1: 100 H: 120	4000 K	5 W	434	0.3
DLD 3 10321 0411 01	L1: 100 H: 120	4000 K	10 W	873	0.3
DLD 3 12321 0314 01	L1: 150 H: 120	4000 K	12 W	1203	0.6
DLD 3 15321 0314 01	L1: 150 H: 120	4000 K	15 W	1525	0.6
DLD 3 20321 0815 01	L1: 190 H: 120	4000 K	20 W	2245	0.9
DLD 3 30321 0815 01	L1: 190 H: 120	4000 K	30 W	3244	0.9

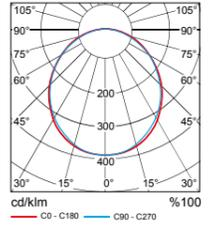
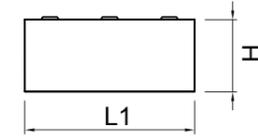
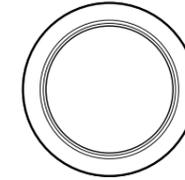

Teknik Özellikler

- > Alüminyum Enjeksiyon Gövde
- > Elektrostatik Toz Boyalı Metal Çerçeve
- > Yüksek Geçirgenlikli Satine PMMA veya PS Opal Difüzör
- > Homojen Aydınlatma
- > MacAdam 3 LED Renk Toleransı
- > DALI ve Acil Kit Seçenekleri

Gövde Rengi

- > RAL Renk Seçenekleri

Not

Talep üzerine driver farklı LED akımları için ayarlanabilir.
LED teknolojilerindeki sürekli değişiklikler nedeniyle, teknik veriler değişiklik gösterebilir.

Quattro Monte

SIVA ÜSTÜ VE SARKIT ARMATÜRLER

Yapınıza değer katan şık ve kullanışlı tavana monte aydınlatma armatürleri.

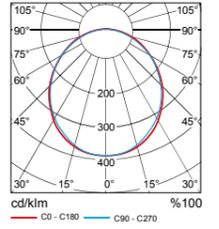
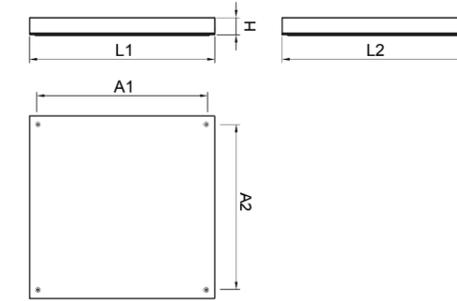

Quattro Monte

Ürün Kodu	Ölçüler (mm)	Renk Sıcaklığı (CRI 80)	Sistem Gücü	Lümen Çıkışı (lm)	Ağırlık (kg)
DLD 1 30251 U310	A1: 575 A2: 575 L1: 595 L2: 595 H: 58	4000 K	30 W	3150	2.9
DLD 1 60251 U510	A1: 575 A2: 575 L1: 595 L2: 595 H: 83	4000 K	38 W	3990	9.2
DLD 1 60251 U510	A1: 575 A2: 575 L1: 595 L2: 595 H: 83	4000 K	42 W	4410	9.2

Teknik Özellikler

- > Polyester elektrostatik toz boyalı
- > Yüksek geçirgenlikli satine PMMA veya PS opal difüzör
- > Mikroprizmatik lens opsiyonu
- > Homojen aydınlatma
- > MacAdam 3 LED Renk Toleransı
- > DALI ve Acil Kit Seçenekleri

Gövde Rengi

- > RAL Renk Seçenekleri

Not

Talep üzerine driver farklı LED akımları için ayarlanabilir.
LED teknolojilerindeki sürekli değişiklikler nedeniyle, teknik veriler değişiklik gösterebilir.

Via

SIVA ÜSTÜ VE SARKIT ARMATÜRLER

Yapınıza değer katan şık ve kullanışlı tavana monte aydınlatma armatürleri.



Via

Ürün Kodu	Ölçüler (mm)	Renk Sıcaklığı (CRI 80)	Sistem Gücü	Lümen Çıkışı (lm)	Ağırlık (kg)
DLD 100026	L1: 1000 L2: 50 H: 75	4000 K	26 W	2735	1.8
DLD 150040	L1: 1500 L2: 50 H: 75	4000 K	40 W	4420	2.5

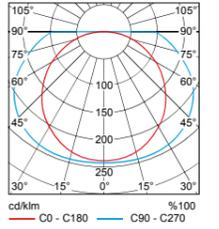
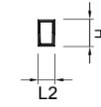
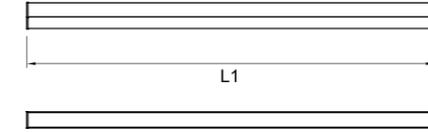

Teknik Özellikler

- > Alüminyum ekstrüzyon gövde
- > Yüksek geçirgenlikli satine PMMA veya PS opal difüzör
- > LED'ler için soğutma tasarımı
- > Sarkıt ve Sıva üstü montaj seçenekleri
- > MacAdam 3 LED Renk Toleransı
- > DALI ve Acil Kit Seçenekleri

Gövde Rengi

- > RAL Renk Seçenekleri

Not

Talep üzerine driver farklı LED akımları için ayarlanabilir.
LED teknolojilerindeki sürekli değişiklikler nedeniyle, teknik veriler değişiklik gösterebilir.

www.dld.com.tr

www.dogusled.com.tr

Karea

SARKIT ARMATÜRLER

Yapınıza değer katan şık ve kullanışlı tavana monte aydınlatma armatürleri.



Karea

Ürün Kodu	Ölçüler (mm)	Renk Sıcaklığı (CRI 80)	Sistem Gücü	Lümen Çıkışı (lm)	Ağırlık (kg)
DLD 3 50351 L550	A1: 555 A2: 625 L1: 645 L2: 645 H: 45	4000 K	50 W	5400	3.6
DLD 3 63351 L650	A1: 1115 A2: 345 L1: 1205 L2: 365 H: 45	4000 K	63 W	6700	4.3
DLD 3 76351 L750	A1: 1115 A2: 345 L1: 1205 L2: 645 H: 45	4000 K	76 W	8000	6.5

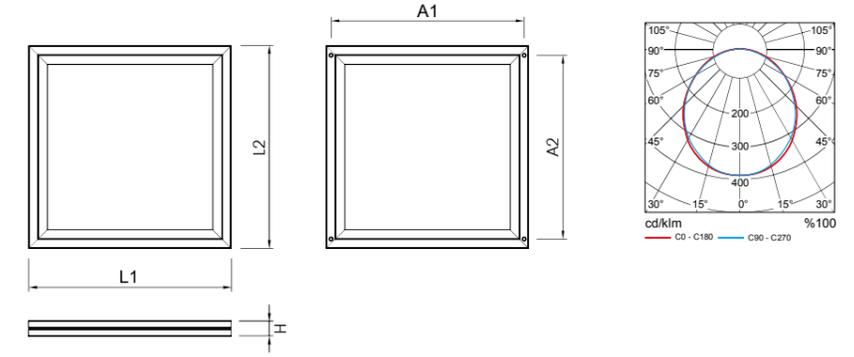

Teknik Özellikler

- > Polyester Elektrostatik Toz Boyalı Alüminyum Ekstrüzyon Gövde
- > Opal Difüzör PC Lens
- > Yatay ve dikey sarkit montaj seçenekleri
- > MacAdam 3 LED Renk Toleransı
- > DALI ve Acil Kit Seçenekleri

Gövde Rengi

- > RAL Renk Seçenekleri

Not

Talep üzerine driver farklı LED akımları için ayarlanabilir.
LED teknolojilerindeki sürekli değişiklikler nedeniyle, teknik veriler değişiklik gösterebilir.

Dia

SARKIT ARMATÜRLER

Yapınıza değer katan şık ve kullanışlı tavana monte aydınlatma armatürleri.



Dia

Ürün Kodu	Ölçüler (mm)	Renk Sıcaklığı (CRI 80)	Sistem Gücü	Lümen Çıkışı (lm)	Ağırlık (kg)
DLD 3 36351 0250	L1: 600 L2: 80 H: 70	4000 K	36 W	2880	4.9
DLD 3 58351 0350	L1: 900 L2: 80 H: 70	4000 K	58 W	4650	7.4
DLD 3 76351 0450	L1: 1200 L2: 80 H: 70	4000 K	76 W	6100	9.8

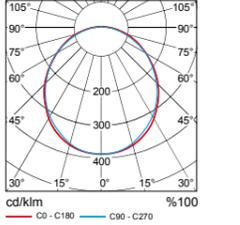
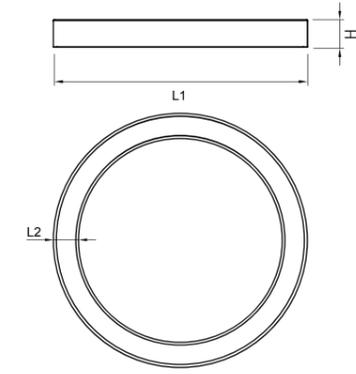

Teknik Özellikler

- > Polyester Elektrostatik Toz Boyalı Alüminyum Ekstrüzyon Gövde
- > Opal Difüzör PC Lens
- > Farklı Ölçü Seçenekleri
- > MacAdam 3 LED Renk Toleransı
- > DALI ve Acil Kit Seçenekleri

Gövde Rengi

- > RAL Renk Seçenekleri

Not

Talep üzerine driver farklı LED akımları için ayarlanabilir.
LED teknolojilerindeki sürekli değişiklikler nedeniyle, teknik veriler değişiklik gösterebilir.



REFERANSLAR



Selçuklu Kongre Merkezi - Konya

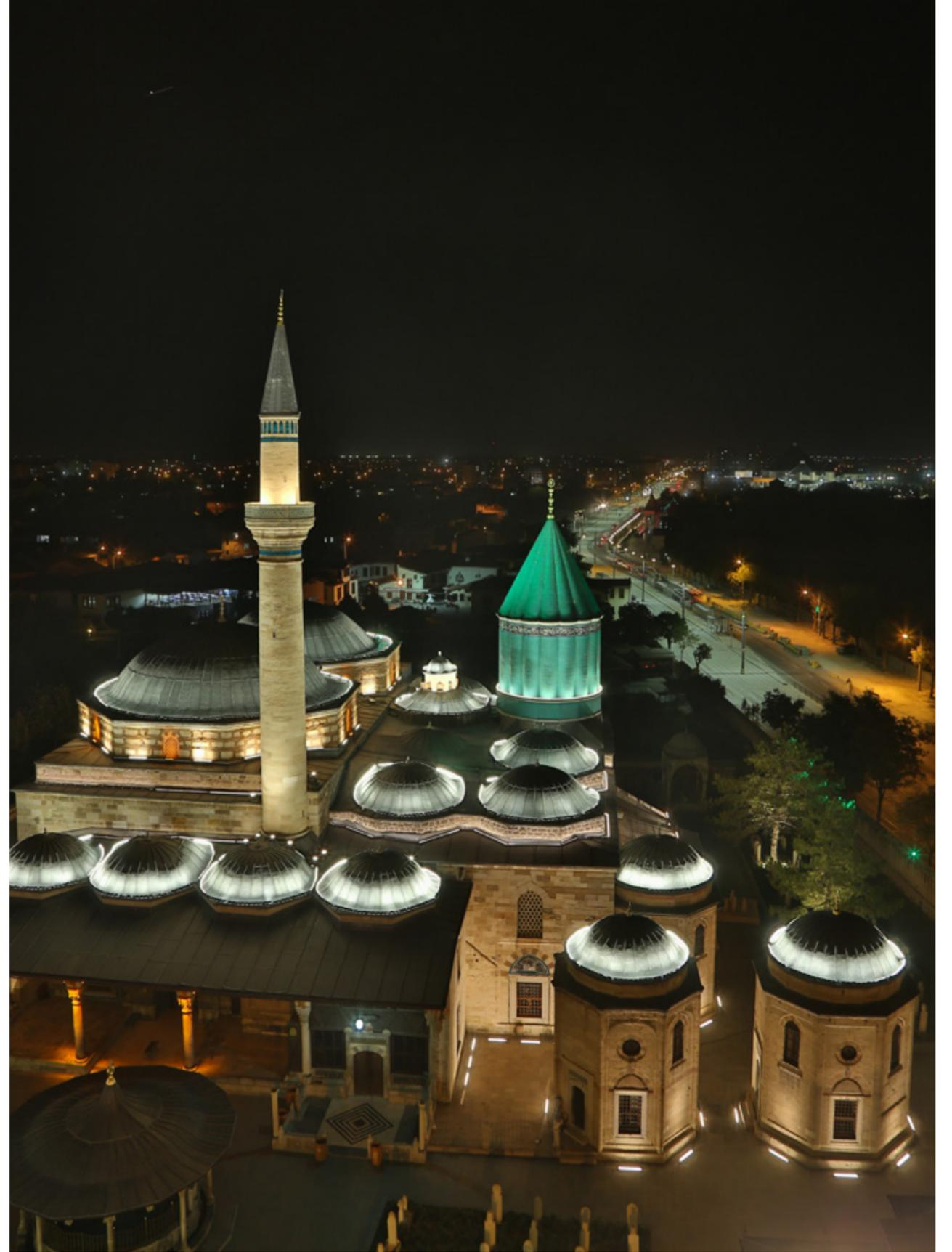

Mevlana Türbesi - Konya

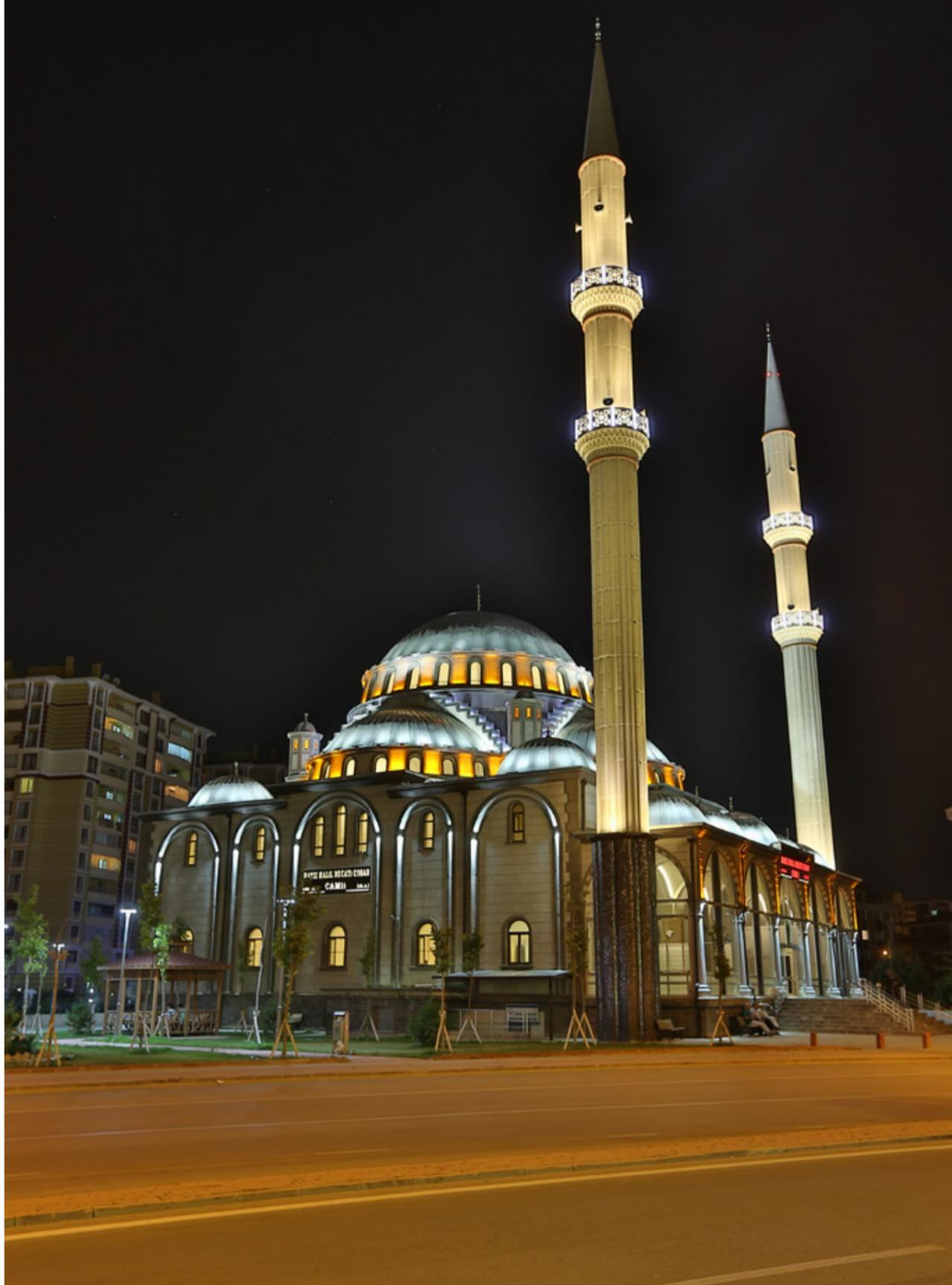

Necati Coşan Camii - Konya

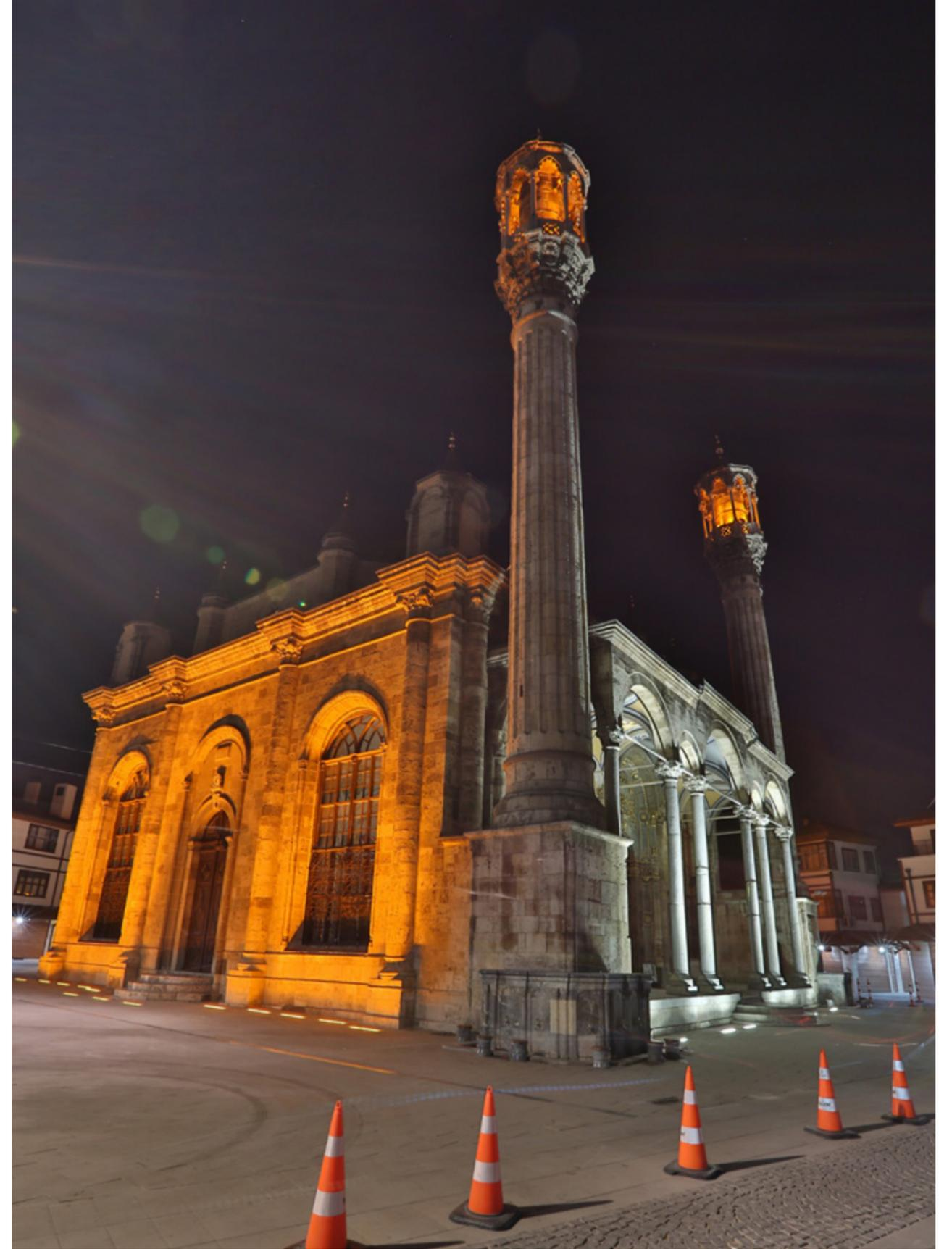

Aziziye Camii - Konya



Selçuklu Aile Yaşam Merkezi - Konya



Otogar Zeki Altındağ Camii - Konya



DLD[®]
DOĞUŞLED LIGHTING DESIGN

KALİTE POLİTİKAMIZ

Sunduğumuz kaliteli, etkin hizmetlerimiz ile bugün; ülkemizde faaliyet gösteren seçkin ve tercih edilen hizmet kuruluşlarından biri olmanın haklı gururunu yaşamaktayız. Hem ulaştığımız kitle hem de takım arkadaşlarımız arasında sinerjiyi yaratabilmek için benimsediğimiz değerler;

Müşterilerimizin kalite, fiyat, teslim süresi ve yüksek standartlardaki beklentilerini sorunsuz bir şekilde karşılamak

Kalite yönetimi süreçleri kapsamında müşterilerimize ve sektöre doğru yanıtlar sunmak

Zamanı iyi kullanıp, ölçülebilir ve ulaşılabilir hedefler doğrultusunda standart bir kalite yönetimi politikası yürütmek

Tüm çalışanlarımızın şirketin amaç ve hedefleri doğrultusunda katılımına teşvik edici kalite yönetim modelleri oluşturmaktır.

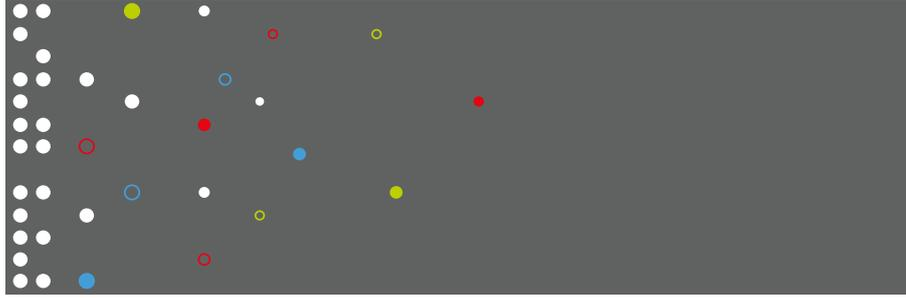

Musalla Baęları Mah. Mahpeyker Sok.
No: 3/C P.K. 42060, Selçuklu - KONYA
Tel: +90 332 236 33 50
info@dogusled.com.tr
www.dogusled.com.tr
www.dld.com.tr